

USER'S MANUAL



FLX-2610

26" LCD Television



This product contains electrical or electronic materials. The presence of these materials may, if not disposed of properly, have potential adverse effects on the environment and human health. Presence of this label on the product means it should not be disposed of as unsorted waste and must be collected separately. As a consumer, you are responsible for ensuring that this product is disposed of properly.



Manufactured under license from Dolby Laboratories.
“Dolby” and the double-D symbol are trademarks of Dolby Laboratories.
Confidential unpublished works. © 1992 -1997 Dolby Laboratories, Inc. All rights reserved.



This TV incorporates High-Definition Multimedia Interface (HDMI™) technology.
HDMI, the HDMI logo and High-Definition Multimedia Interface are trademarks or registered trademarks of HDMI Licensing LLC.

Federal Communications Commission Statement



ENGLISH

This equipment has been tested and found to comply with the limits of a class B digital device, pursuant to Part 15 of the FCC Rules. These limits are designed to provide reasonable protection against harmful interference in a residential installation. This equipment generates, uses and can radiate radio frequency energy and, if not installed and used in accordance with the instructions, may cause harmful interference to radio communications. However, there is no guarantee that interference will not occur in a particular installation. If this equipment does cause harmful interference to radio or television reception, which can be determined by turning the equipment off and on, the user is encouraged to try to correct the interference by one or more of the following measures:

1. Reorient/Relocate the receiving antenna.
2. Increase the separation between the equipment and receiver.
3. Connect the equipment into an outlet on a circuit which is different from what the receiver is connected to.
4. Consult the dealer or an experienced radio/TV technician for help.



Changes or modifications not expressly approved by the manufacturer responsible for compliance could void the user authority to operate the equipment.

Warnings and Precautions

To prevent any injuries, the following safety precautions should be observed in the installation, use, servicing and maintenance of this equipment.
 Before operating this equipment, please read this manual completely, and keep it nearby for future reference.



WARNING

This symbol is intended to alert the user to avoid the risk of electric shock.
 This equipment must not be disassembled by anyone except qualified service personnel.



CAUTION

This symbol is intended to alert the user to the presence of important operating and maintenance instructions in the literature accompanying the appliance.



To reduce the risk of fire or electric shock, do not expose this equipment to rain or moisture.

- TO REDUCE THE RISK OF ELECTRIC SHOCK,
- DO NOT REMOVE COVER (OR BACK).
- NO USER-SERVICEABLE PARTS INSIDE.
- REFER SERVICING TO QUALIFIED SERVICE PERSONNEL.



Use of controls, adjustments or performance of procedures other than those specified herein may result in hazardous radiation exposure.

Important Safety Instructions



This symbol indicates caution points.



This symbol indicates actions that should not be done.



This symbol indicates actions that must be performed.



- Do not place the equipment on any uneven or unstable carts, stands, tables, shelves etc. The equipment may fall, causing serious injury to children or adults and serious damage to the equipment itself.



- Use only a cart or stand recommended by the manufacturer. This equipment and recommended cart or stand should be handled with care. Quick stops, excessive force, and uneven surfaces may cause the equipment and cart/stand to overturn.



- Do not disable the 3-wire grounding type plug. The grounding pin on the 3-prong plug is an important feature. Removing the grounding pin will increase the risk of damaging the equipment.
- If you can not fit the plug into the electrical outlet, contact an electrician to install a grounding outlet.
- Always operate this equipment from the type of power source indicated on the rear of the serial/model plate.
- Never overload wall outlets and extensions.



- Use and handle the power cord with care. Do not place any heavy objects on the AC power cord.
- Do not pull the AC power cord. Do not handle the AC power cord with a wet hand.
- Do not touch the power cord and antenna cable during lightning.
- Remove the plug from the wall outlet, if the equipment will not be used for a long period of time.
- Do not place, use or handle this equipment near water.
- Never expose the equipment to liquid, rain, or moisture. Seek for service if any of the above is spilled into the equipment.
- Do not expose the equipment to extreme temperature or to direct sunlight, as the equipment may heat up and suffer damage.
- Do not install the equipment near any heat sources such as radiators, heat registers, stoves, or any other apparatus that might produce heat.
- Do not attempt to service the equipment yourself.
- Opening and removing the covers may expose you to dangerous voltage or other hazards and may void your warranty. Refer service to qualified personnel.
- Do not place or drop any other objects on top.
- Do not insert anything into the ventilation holes of your equipment. Inserting any metal or flammable objects may result to fire or electric shock.
- Protect the power cord from being walked on or pinched particularly at plugs, convenience receptacles, and the point where they exit from the apparatus.
- Do not place the equipment on uneven or unstable carts, stands, tables, shelves etc. The equipment may fall, causing serious injury to children or adults and serious damage to the equipment itself. Always place the equipment on the floor or on a surface that is sturdy, level, stable and strong enough to support the weight of the equipment.
- Do not block any ventilating openings. Leave an open space around the equipment. Never place the equipment : on a bed, sofa, rug, or any other similar surfaces; too close to drapes/curtains/walls, in a bookcase, built-in cabinet, or any other similar places that may cause poor ventilation.
- Unplug this apparatus during lightning storms or when unused for long periods of time.
- Refer all servicing to qualified service personnel. Servicing is required when the apparatus has been damaged in any way, such as power-supply cord or plug is damaged, liquid has been spilled or objects have fallen into the apparatus, the apparatus has been exposed to rain or moisture, does not operate normally, or has been dropped.



- Always remove the power cord from the outlet before cleaning the equipment.
- Never use liquid or aerosol cleaners on the equipment. Clean only with a soft dry cloth.



- Only use attachments/accessories specified by the manufacturer.

Antenna Safety Instructions

If an outdoor antenna is connected, follow the precautions below:



- An outdoor antenna should not be located in any area where it could come in contact with overhead power lines, or any other electric light or power circuits.
- When installing an outdoor antenna system, extreme caution should be taken to prevent contact with power lines. Direct contact with power lines may be fatal and should be avoided at all costs.

Section 810 of National Electrical Code (NEC) provides information with respect to proper grounding of the mast and supporting structure, grounding of the lead-in wire to an antenna discharge unit, size of grounding conductors, location of antenna discharge unit, connection to grounding electrodes, and requirements for the grounding electrode.

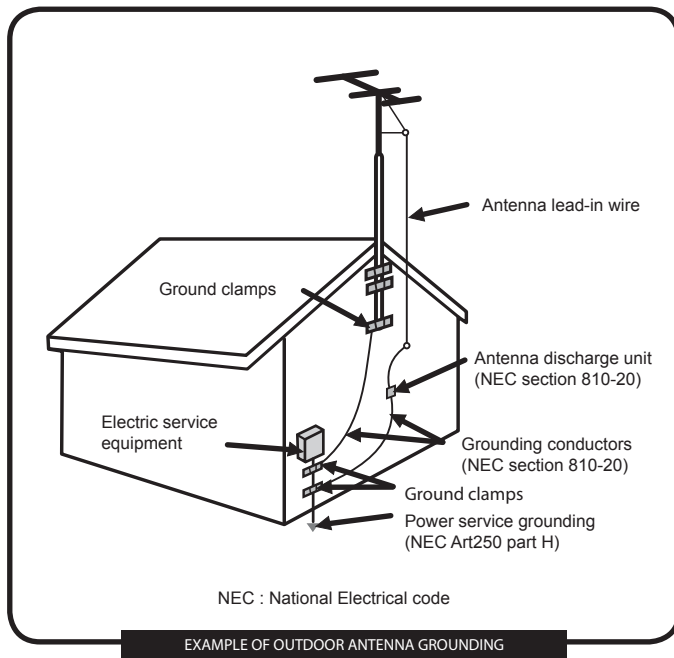

TABLE OF CONTENTS



- **Federal Communications Commission Statement** 1

- **Warnings and Precautions**
 - Important Safety Instructions 2
 - Antenna Safety Instructions 4

- **Chapter 1 Introducing the LCD TV**
 - Key Features 6
 - Package Contents 7
 - Setting Your LCD TV 8
 - Your LCD TV 10
 - Your Remote Control 12

- **Chapter 2 Installing the LCD TV**
 - Connecting a TV Cable or an Antenna 14
 - Connecting a VCR 19
 - Connecting a Video Camera or Game Console 20
 - Connecting a DVD Player 21
 - Connecting a Digital TV Cable Box or Digital Satellite Receiver 23
 - Connecting an AV Equipment with HDMI Connector 24
 - Connecting an AV Equipment with DVI Connector 25
 - Connecting a PC 26
 - Connecting an Audio Receiver or a Dolby Digital 5.1 Sound System 27

- **Chapter 3 USING THE FEATURES**
 - Wide Screen Viewing 29
 - Operating the Menu 30
 - Customizing the VIDEO Settings 32
 - Customizing the AUDIO Settings 34
 - Customizing the TV Settings 36
 - Customizing the SETUP Settings 38
 - Using the Program Block Settings 41
 - Using the Program Guide 46

- **Specifications** 47

Chapter 1

Introducing the LCD TV

Key Features

Various Audio/Video terminals for external equipment connection

- 2 sets of composite A/V input terminals
- 1 set of S-VIDEO terminals
- 2 sets of component Video input terminals
- 1 VGA/ Audio input terminals
- 1 HDMI/Audio input terminals
- 1 set of Audio(L/R) output terminals
- 2 SPDIF output terminals (Optical x 1 /Coaxial x 1)
- 1 Headphone terminal

The built-in TV tuner to receive HD ATSC

- This function allows the reception of HD broadcasting without the addition of a set top box.

High Definition Multimedia Interface (HDMI)

- High Definition Multimedia Interface (HDMI) is a small, user-friendly interconnect that can carry up to 5 Gbps of combined video and audio in a single cable. This system eliminates the cost, complexity and confusion of multiple cables used to connect current A/V systems.

HDTV Component Video Inputs

- Offers the best video quality for DVD(HD1080p,1080i, 720p) and digital set-top-box (HD1080p,1080i, 720p) connections.

3D Digital Noise Reduction

- This function can digitally reduce image noise to provide better picture quality.

Film-Mode Detection (3:2 Reverse Pull Down)

- This function can automatically detect content derived from film and adjust the interlacer's frame matching to provide a more natural-looking, clearer image of the moving picture.

Package Contents

Make sure all of the following contents are included.

- LCD TV



- Bottom Stand / Screw Driver and Screws (4~6)

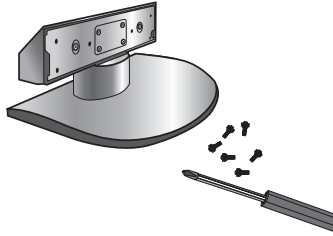

- Remote Control/
AAA Batteries x 2

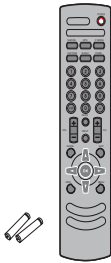

- VIDEO Cable



- Component Cable

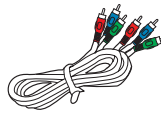

- Power Cord



- AUDIO Cable

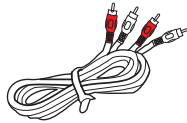

- Warranty Card

- User's Manual
- Stand Assembly Guide

- Quick Start Guide
- Remote Control Guide

These items are all you need to set up and operate the LCD TV in its basic configuration.



Make sure all of the above contents are included in the package. If you are missing any items, please contact the Element Electronics customer service department.

Setting Up Your LCD TV

How to install the TV Stand

Read all instructions before continuing with the stand installation.



Attach the Stand the TV with the bottom foam packaging material still attached.

- Lift foam packaging material from the top of the LCD out of the box.
- Lift LCD out of the box, with the bottom foam packaging material still attached, and place onto a stable surface.

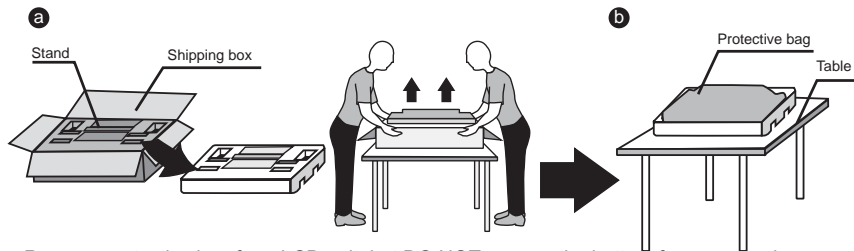

- Remove protective bag from LCD unit, but DO NOT remove the bottom foam packaging material from the TV.
- Locate the place on the back of the TV to attach the stand. Secure the stand to the LCD with all six screws.

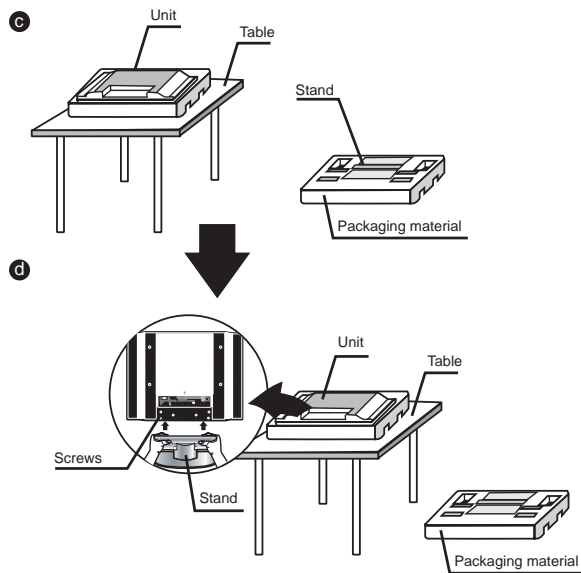

How to remove the TV Stand

If you prefer to mount your new Element Electronics TV on a wall instead of attaching it to the stand, please reference the instructions included in the wall mounting kit (sold separately).



Verify your TV's model and be sure to use the wall mounting kit (100 x 100) specified for your TV model only. Contract a qualified technician for assistance when installing the wall mounting kit.

ENGLISH

- 1 To prevent damaging the surface of the LCD TV, place the TV on a soft cloth.

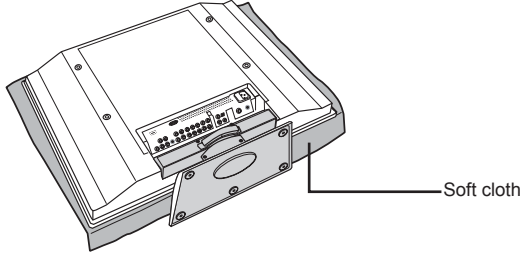

- 2 Remove the screws of the table stand and detach the table stand from the TV.

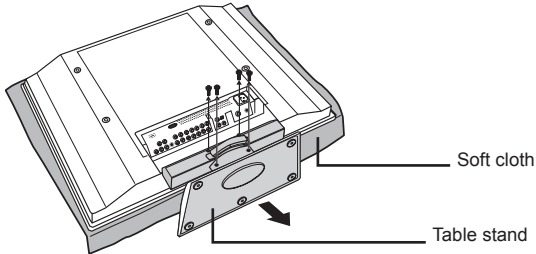

- 3 Align the holes on the wall mounting hook units with the corresponding holes on the rear of the TV and fasten four screws.

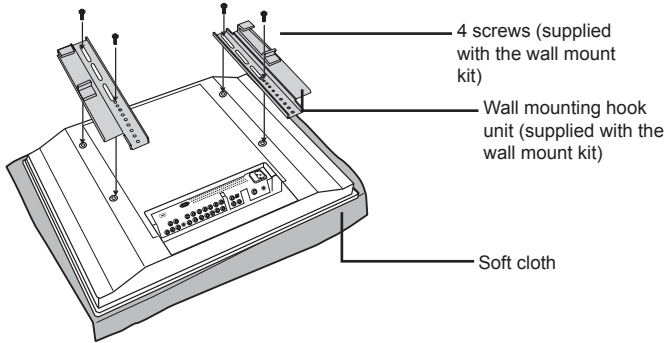

How to setup the TV

- 1 Use a supplied antenna cable to connect the VHF/UHF signal to the LCD TV's ANT. terminal (refer to page15-17).
- 2 Connect the AC power cord at the back of the TV and connect the power cord to wall outlet.
- 3 Insert the 2 batteries supplied in remote control.

Step1 Slide the back cover up to open the battery compartment of the remote control.

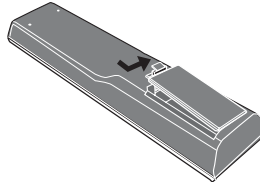

Step2 Insert two AAA size batteries. Make sure to match the (+) and (-) ends of the batteries with the (+) and (-) ends indicated in the battery compartment. Slide the cover back into place.

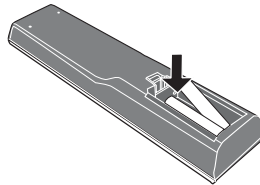

Do not use caustic cleaners (porcelain, stainless steel, toilet, or oven cleaner etc.) on the remote, as it may suffer damage.

- 4 To connect to another external A/V device, refer to pages 19-27.

Your LCD TV

Front/Right Side View and Controls

ENGLISH

LED
The LED light indicates when the LCD TV is activated.

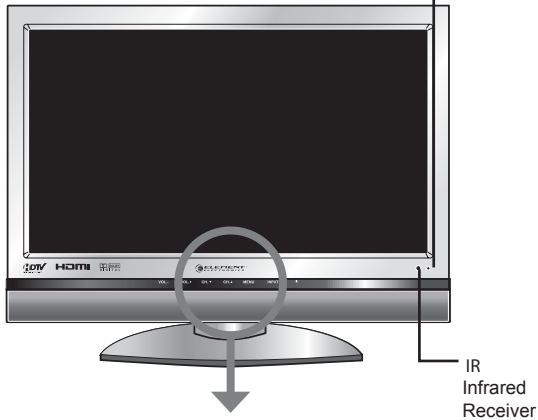

VOLUME+/-

Adjusts the volume up and down. Selects the main-menu item and change values for items when in the OSD mode.

CHANNEL▲▼

Scans up and down through channels. Selects sub-menu item when in the OSD mode.

MENU

Press once to display the OSD (on screen display), press again to turn the OSD off.

INPUT

Chooses from different input signal sources.



Turns the LCD TV on and into standby mode.

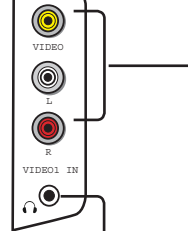

VIDEO1 IN

Connects to the composite Video and Audio output jacks on external video equipment.

HEADPHONE

Connects to the external headphone for private listening.

Rear View and Jacks

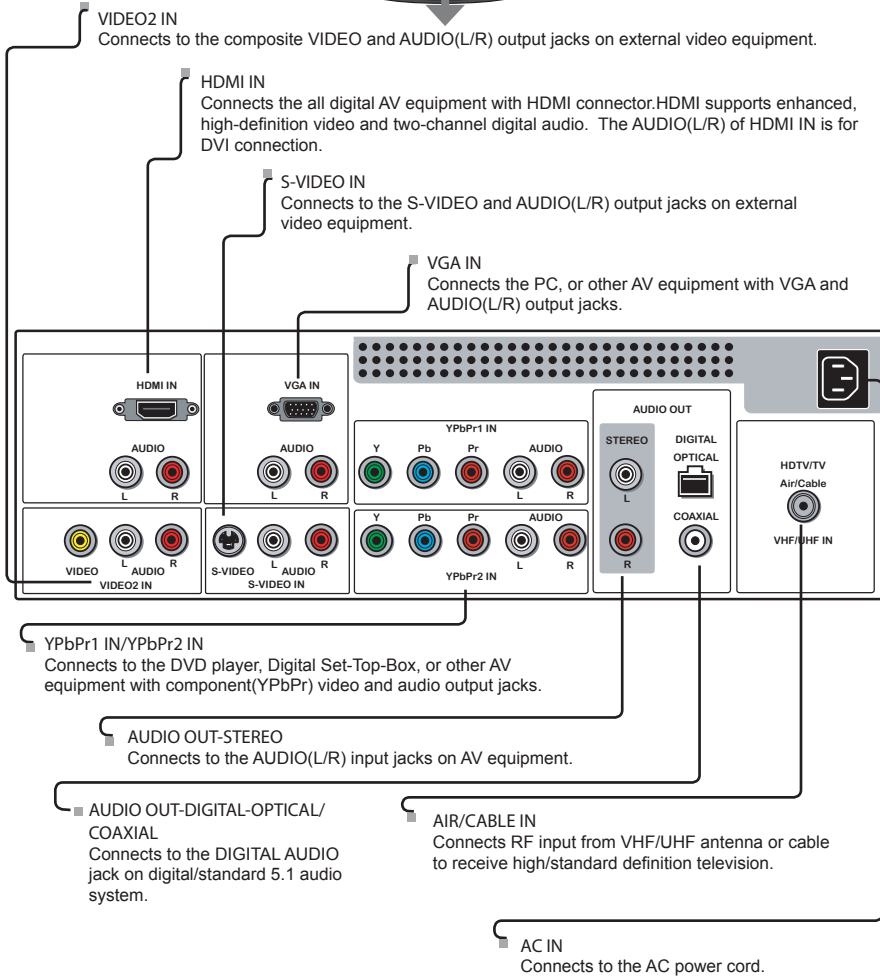

Your Remote Control

ENGLISH

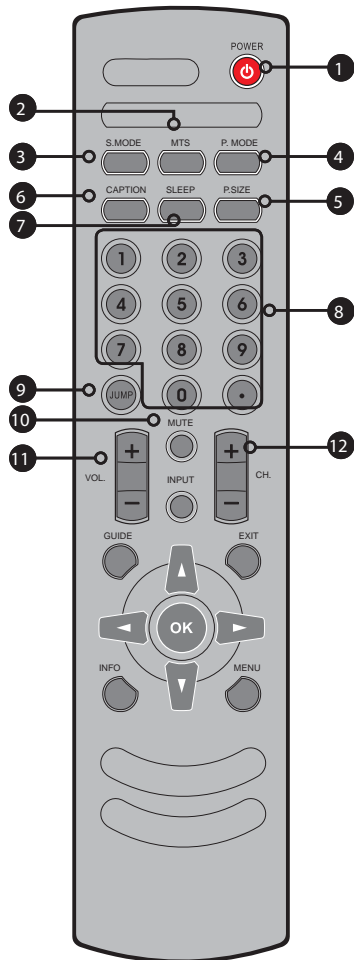

- | | | |
|----|---------|--|
| 1 | | Turns the LCD TV on and off. |
| 2 | MTS | Cycles through the multi-channels TV sound(MTS) options: SAP/MONO/STEREO |
| 3 | S.MODE | Selects sound effect options: Surround/Live/Dance/Techno/Classic/Soft/Rock/Pop/Off. |
| 4 | P.MODE | Selects picture mode: Vivid/Hi-Bright/Cinema/Sport/User |
| 5 | P.SIZE | Cycles through Wide mode settings : NORMAL /FULL/WIDE/ZOOM |
| 6 | CAPTION | Cycles through the Closed Caption: <ul style="list-style-type: none"> ▪ Analog Closed Caption:CC1/CC2/CC3/CC4/TT1/TT2/TT3/TT4/Off ▪ Digital Closed Caption:Service1/Service2/Service3/Service4/Service5/Service6/Off |
| 7 | SLEEP | Cycles through the LCD TV sleep timer: OFF/10/20/30/40/50/60/90/120 mins |
| 8 | 0-9 | Select and switch to a channel by using 0-9 buttons. <ul style="list-style-type: none"> • In HDTV mode, use with 0-9 and • buttons to select a digital channels. |
| 9 | JUMP | Returns to previously selected channel. |
| 10 | MUTE | Mutes and restores the audio |
| 11 | VOL.+/- | Increases and decreases volume. |
| 12 | CH.+/- | Scans up and down the channels |

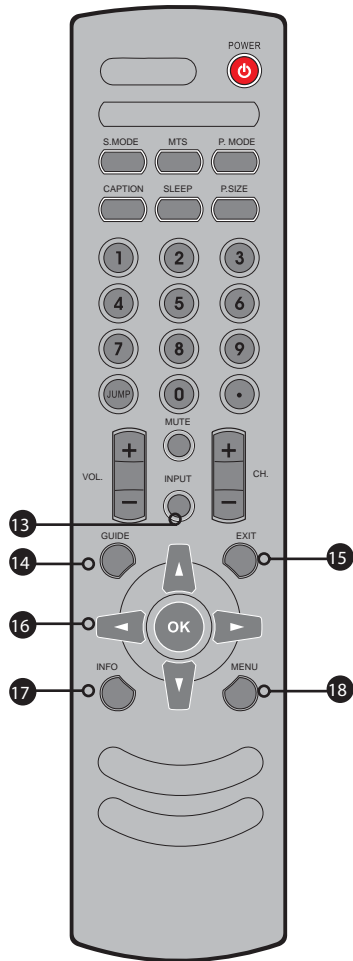

13 INPUT Pressing **INPUT** display the source list, use **▲▼** to select the video equipment connected to the video inputs of your LCD TV : TV/HDTV/VIDEO1/VIDEO2/VIDEO3/VIDEO4/VIDEO5/VIDEO6/COMPUTER

Input Source
TV(CABLE/AIR)
VIDEO1 (SIDE)
VIDEO2 (REAR)
VIDEO3 (S-VIDEO)
VIDEO4 (YPbPr1)
VIDEO5 (YPbPr2)
VIDEO6 (HDMI1)
VIDEO7 (HDMI2)
COMPUTER(VGA)

14 GUIDE Displays the Program Guide on the screen. Pressing again to turn GUIDE off.

15 EXIT Exits the OSD menu.

16 **▲▼▶◀**
OK Cycles through OSD options and selects individual menu items. OK confirms option settings.

17 INFO Pressing repeatedly displays a variety of information such as the current channel and the input source.

18 MENU Displays the OSD menu on the screen.



Effective range:
The remote can control the LCD TV from up to 5m away, if pointed directly at the receiver.

Chapter 2

Installing the LCD TV

Refer to the owner's manual of any external equipment to be connected.
When connecting any external equipment, do not connect any AC power cords to wall outlets until all other connections are completed.

ENGLISH

Connecting a TV Cable or an Antenna

Antenna Connection

The antenna requirements for good color TV reception are more important than those for a black & white TV reception. For this reason, a good quality outdoor antenna is strongly recommended. The following is a brief explanation of the type of connection that is provided with the various antenna systems.

- A 75-ohm system is generally a round cable (not included) with F-type connector that can easily be attached to a terminal without tools.

F-type connector



75-ohm coaxial cable (round)

- A 300-ohm system is a flat twin-lead cable (not included) that can be attached to a 75-ohm terminal through a 300-75-ohm adapter (not included).



300-ohm twin-lead cable (flat)

Use one of the following two diagrams when connecting an outdoor antenna.

A: Shows how to use a VHF/UHF combination outdoor antenna.

B: Shows how to use a separate VHF and/or UHF outdoor antenna.

A. Combination VHF/UHF antenna

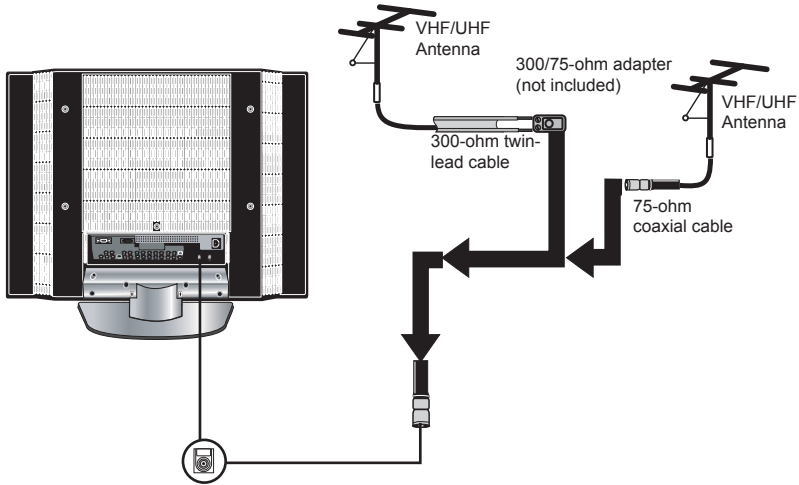

B. Separate VHF and/or UHF antennas

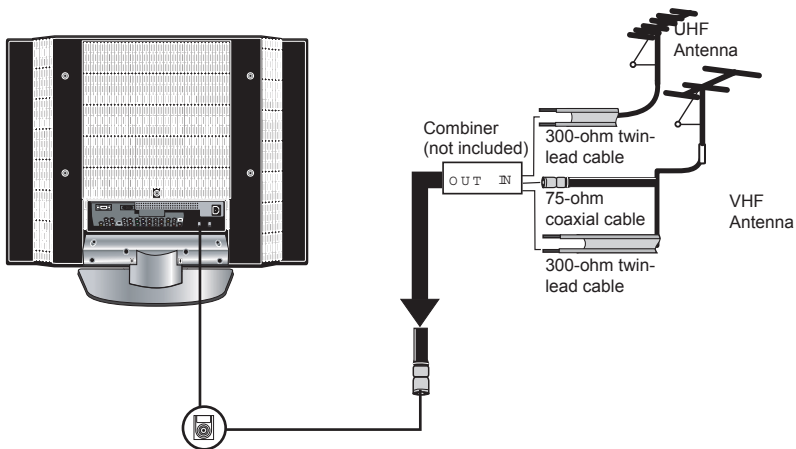

Cable TV (CATV) Connection

This reminder is provided to call the CATV system installer's attention to Article 820-40 of the National Electrical Code (NEC) that provides guidelines for proper grounding and, in particular, specifies that the cable ground shall be connected to the grounding system of the building accurately, or as close to the point of cable entry as possible. Use of this TV for other than private viewing of programs broadcasted on UHF, VHF or transmitted by cable companies for the use of the general public may require authorization from the broadcast/cable company, and/or program owner.

- A 75-ohm coaxial cable connector is built into the set for easy hookup. When connecting the 75-ohm coaxial cable to the set, connect the 75-ohm cable into the ANT. terminal.
- Some cable TV companies offer premium pay channels. Since the signals of these premium pay channels are scrambled, a cable TV converter/descrambler is generally provided to the subscriber by the cable TV company.

This converter/descrambler is necessary for normal viewing of scrambled channels. (Set your TV to channel 3 or 4, typically one of these channels is used. If this is unknown, consult your cable TV company.)

For more specific instructions on installing cable TV, consult your cable TV company.

One possible method of connecting the converter/descrambler provided by your cable TV company is shown in the diagram below.

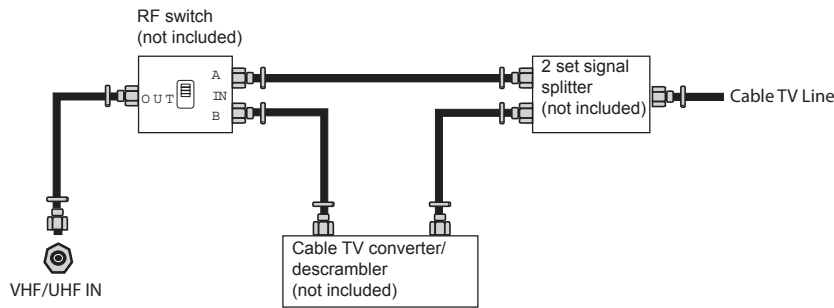

- ⚠ The RF switch (not included) is required to provide two inputs (A and B). Setting the RF switch to position A allows viewing of all unscrambled channels by using the TV channel keys.
- Setting the RF switch to position B allows viewing of all scrambled channels via the converter/descrambler by using the converter channel keys.

- 1 Use a supplied antenna cable to connect the TV signal to the LCD TV's TV CABLE terminal.

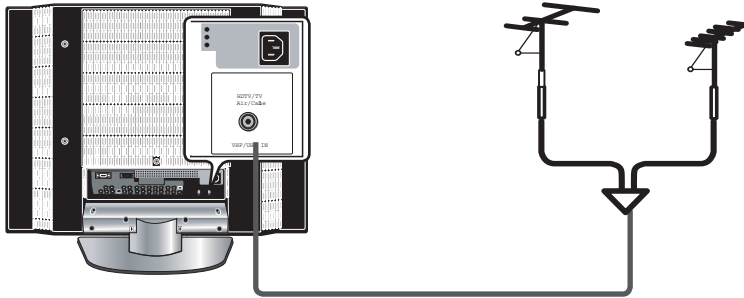

- 2 Connect the AC power cord at the back of the TV and connect the power cord to wall outlet.

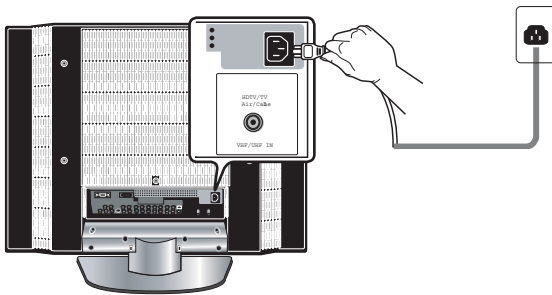

This TV is equipped with a safety fuse. In the event of an electrical storm or power outage the safety fuse is designed to protect your TV. If your TV has no power, check the fuse by prying the cover off, following the illustration below. If the fuse is blown, visit your local hardware store and ask for a 4A 250V - 5x20mm Time Lag Fuse (Slow Blow) to replace the fuse.



! BE SURE TO UNPLUG AC POWER CORD BEFORE REMOVING THE FUSE.



- 3 Press the  button on the remote to turn on the LCD TV.

! Always disconnect the LCD TV from the main power source when the LCD TV will not be used for a long period of time. The POWER button on the front panel is only used for switching the LCD TV into the standby mode, it does not disconnect the device from the main power source. To completely disconnect the main power source, please remove the power cord's plug from the socket.

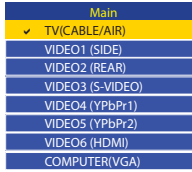

- 3 Press the  button on the remote to turn on the LCD TV.



ENGLISH

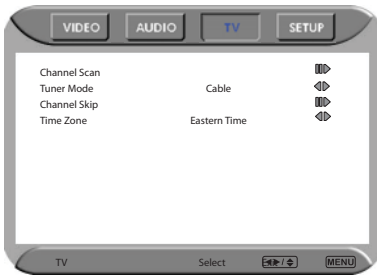

- 4 Press the INPUT button on the remote to display the Input List. Use the   buttons to select TV and press the OK button.



- 5 Press the MENU button on the remote control to display the Main menu, and use the   buttons to select the TV.



 The Channel Scanning will create a list of receivable channels for the current input (antenna or cable). You will be required to run Channel Scanning for each RF input to create a list of available channels from both inputs.

- 7 Press the OK button to display the received channel list, then press   to select a channel. Or, use the  (Input button) with 0-9 buttons to select digital channel(for example 9.1)



 The digital main channel might include many subchannels (for example 9-1, 9-2..) that are showing program at the same time.

Connecting a VCR

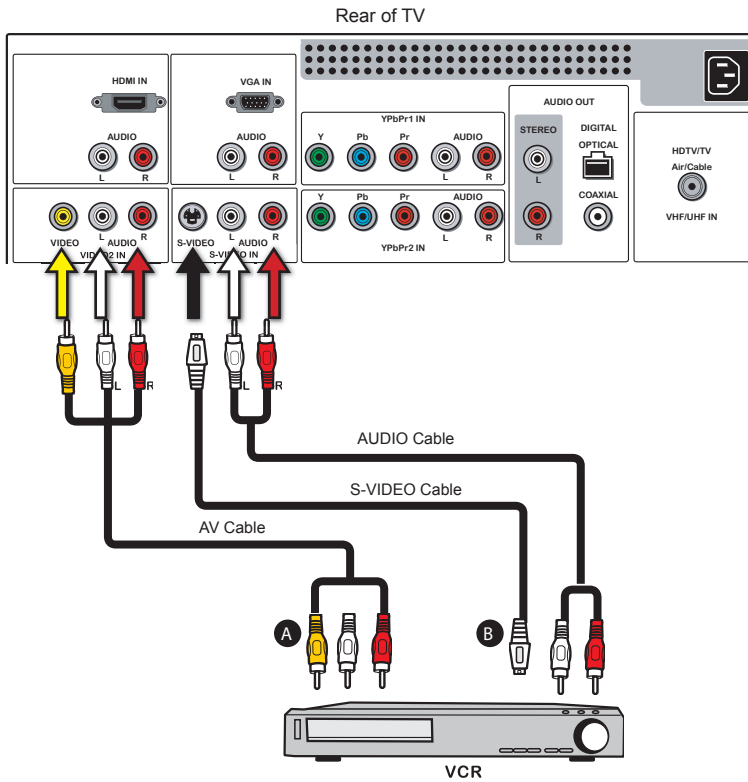

1

METHOD A:

Use a composite cable to connect the VCR's composite video/audio jacks to the LCD TV's VIDEO2 IN jacks.

METHOD B:

Use an audio cable to connect the VCR's audio output jacks to the LCD TV's audio inputs. Use a S-Video cable to connect the VCR's s-video output jack to the LCD TV's S-VIDEO IN input jack.

2

Connect all AC power sources, before turning on the power switch of the LCD TV or other connected equipment.

3

Press the  button on the remote to turn on the LCD TV.

4

To watch a videotape, press the SOURCE button on the remote to select VIDEO2 (METHOD A), or VIDEO3 (METHOD B).

Connecting a Video Camera or Game console

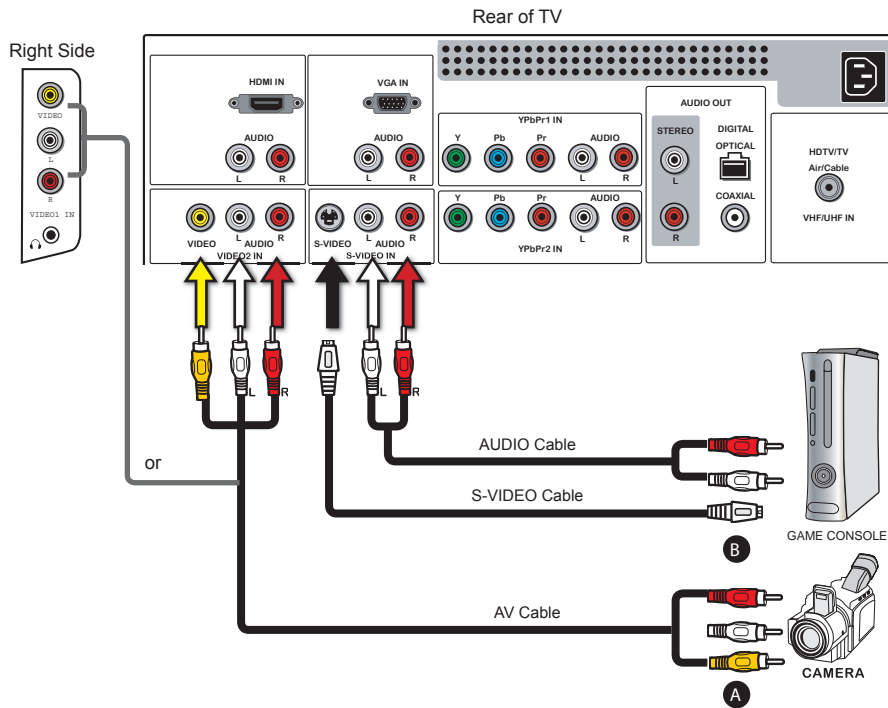

1

METHOD A:

Use a composite cable to connect the video camera's or game console's composite video/audio jacks to the LCD TV's VIDEO2 IN jacks or VIDEO1 IN jacks.

METHOD B:

Use an audio cable to connect the video camera's or game console's audio output jacks to the LCD TV's audio inputs. Use an S-Video cable to connect the video camera's or game console's s-video output jack to the LCD TV's S-VIDEO IN input jack.

2

Connect all AC power sources, before turning on the power switch of the LCD TV or other connected equipment.

3

Press the  button on the remote to turn on the LCD TV.

4

To watch a video vis camera or game console, press the Input button on the remote to select VIDEO2/VIDEO1(METHOD A), or VIDEO3 (METHOD B).



Not all cameras have the ability to connect to a TV. Please check your video camera user guide for compatibility.

Connecting a DVD Player

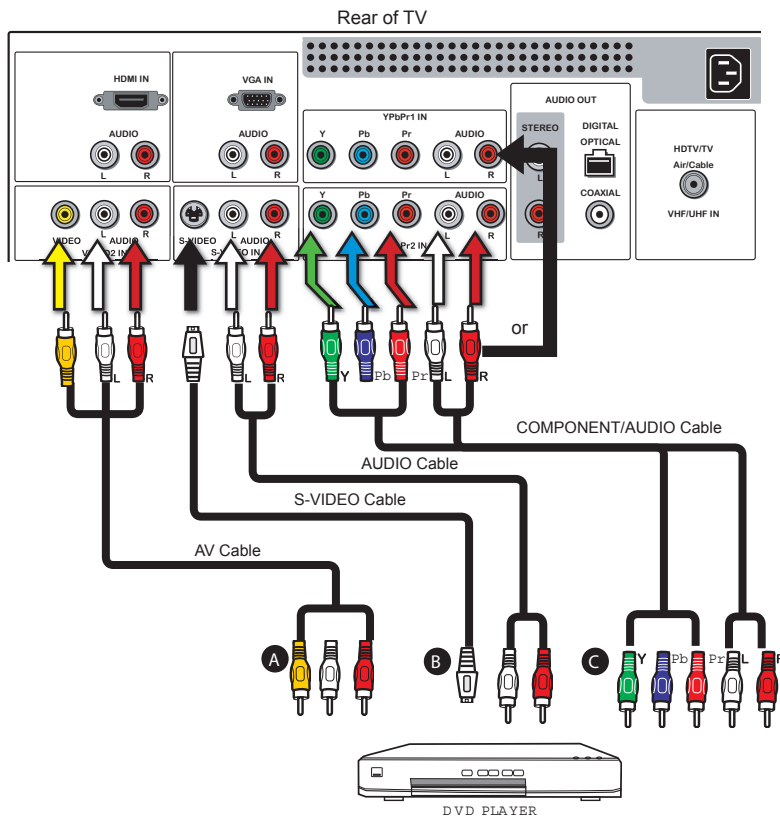

1

METHOD A:

Use a composite cable to connect the DVD player's composite video/audio jacks to the LCD TV's VIDEO2 IN jacks.

METHOD B:

Use an audio cable to connect the DVD player's audio output jacks to the LCD TV's audio inputs. Use an S-Video cable to connect the DVD player's s-video output jack to the LCD TV's S-VIDEO IN input jack.

METHOD C:

Use a component cable to connect the DVD player's component output jacks to the LCD TV's YPbPr1 IN or YPbPr2 IN input jacks.

Use an audio cable to connect the DVD player's component audio jacks to the LCD TV's audio input jacks.





The component video jacks on your DVD player are sometimes labeled YPbPr, or YCbCr. For an explanation of component video, see your DVD player's user guide.

- 2 Connect all AC power sources, before turning on the power switch of the LCD TV or other connected equipment.
- 3 Press the  button on the remote to turn on the LCD TV.
- 4 To watch a DVD, press the Input button on the remote to select VIDEO2(METHOD A), or VIDEO3 (METHOD B), or VIDEO4/VIDEO5 (METHOD C).

 For best picture quality, if your equipment has component video output, use a component cable instead of a composite video or S-video cable.

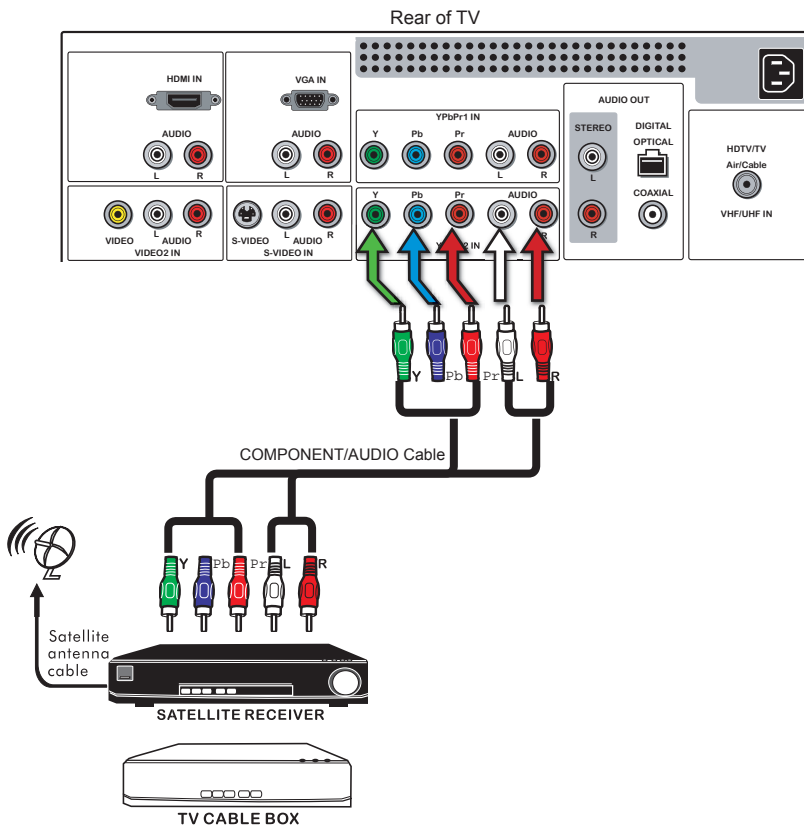
Connecting a Digital TV Cable Box or Digital Satellite Receiver



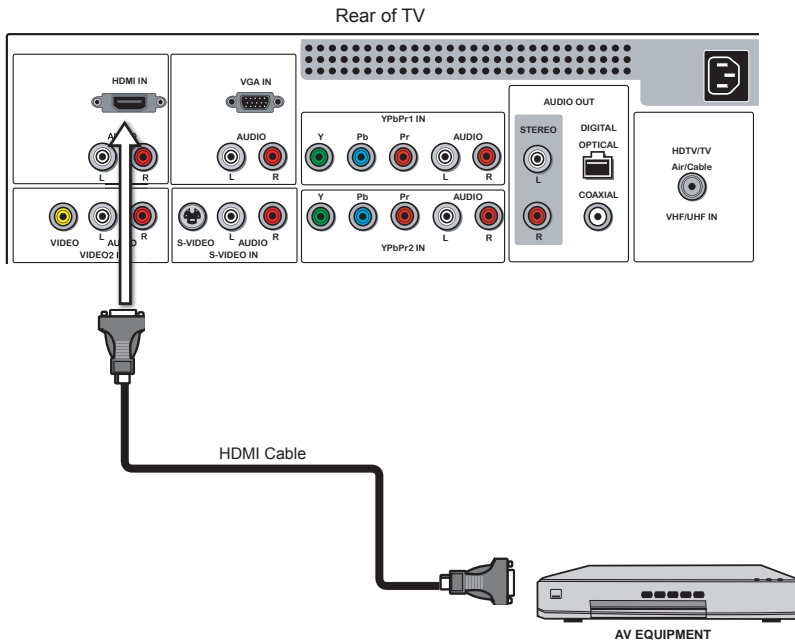

- 1** Use a component cable to connect the satellite receiver's/TV Cable Box's component (YPbPr1) output jacks to the LCD TV's component input jacks. Use an audio cable to connect the satellite receiver's/TV Cable Box's component audio jacks to the LCD TV's audio input jacks.
- 2** Connect all AC power sources, before turning on the power switch of the LCD TV or other connected equipment.
- 3** Press the  button on the remote to turn on the LCD TV.
- 4** To watch programs via satellite receiver or TV Cable Box, press the Input button on the remote to select VIDEO4/VIDEO5.

Connecting an AV Equipment with HDMI Connector





ENGLISH

- 1 Use a HDMI cable to connect the AV equipment's HDMI output jack to the LCD TV's HDMI IN jacks.
- 2 Connect all AC power sources, before turning on the power switch of the LCD TV or other connected equipment.
- 3 Press the  button on the remote to turn on the LCD TV.
- 4 Press the Input button on the remote to select VIDEO6.

 The HDMI connector provides both video and audio signals, it's not necessary to connect the audio cable.

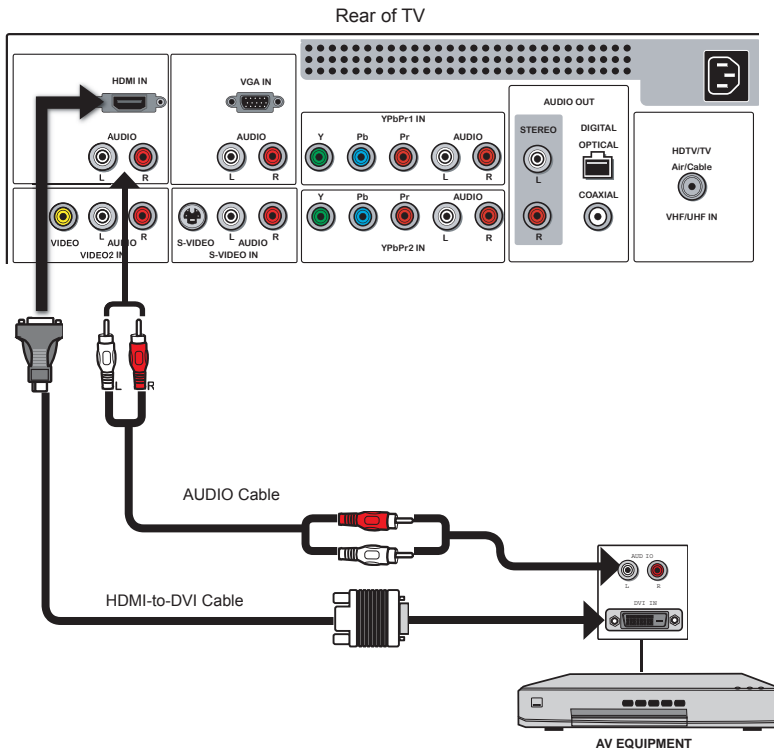
Connecting an AV Equipment with DVI Connector



- 1 Use a HDMI-to-DVI cable to connect the AV equipment's DVI output jack to the LCD TV's HDMI IN jacks.
Use an audio cable to connect the AV equipment's audio output jacks to LCD TV's HDMI AUDIO jacks.
- 2 Connect all AC power sources, before turning on the power switch of the LCD TV or other connected equipment.
- 3 Press the  button on the remote to turn on the LCD TV.
- 4 Press the Input button on the remote to select VIDEO6.



If the LCD TV is connected to AV equipment's DVI connector, you will need an HDMI-to-DVI cable or an HDMI adapter(not supplied) and an audio cable.

Connecting a PC

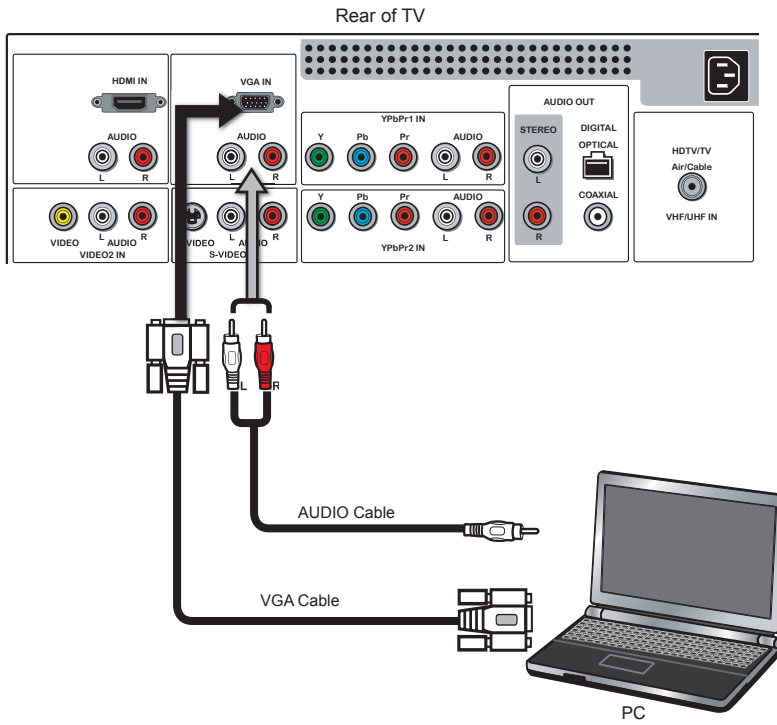

ENGLISH

- 1 Use a D-SUB cable to connect the PC's D-SUB output jack to the LCD TV's VGA input jack. Use an audio cable to connect the PC's audio output jacks to LCD TV's.
- 2 Connect all AC power sources, before turning on the power switch of the LCD TV or other connected equipment.
- 3 Press the  button on the remote to turn on the LCD TV.
- 4 Press the Input button on the remote to select COMPUTER.

Connecting an Audio Receiver or a Dolby Digital 5.1 Sound System

For better sound quality, you may want to use a Home Theater/Stereo System.

NOTE: If you have a Home Theater/Stereo System that you would like to use with your new Element Electronics TV, we recommend that you do NOT use your TV's audio output for this connection.

For the best sound quality, our product testing has shown that you should connect your Home Theater/Stereo System directly to your A/V device. I.E. You should connect your Home Theater/Stereo System to your DVD player, Cable/Satellite box or other AV equipment.

Although not recommended, if you prefer to use the TV audio output to make this connection to your Home Stereo System, please follow the instructions below.

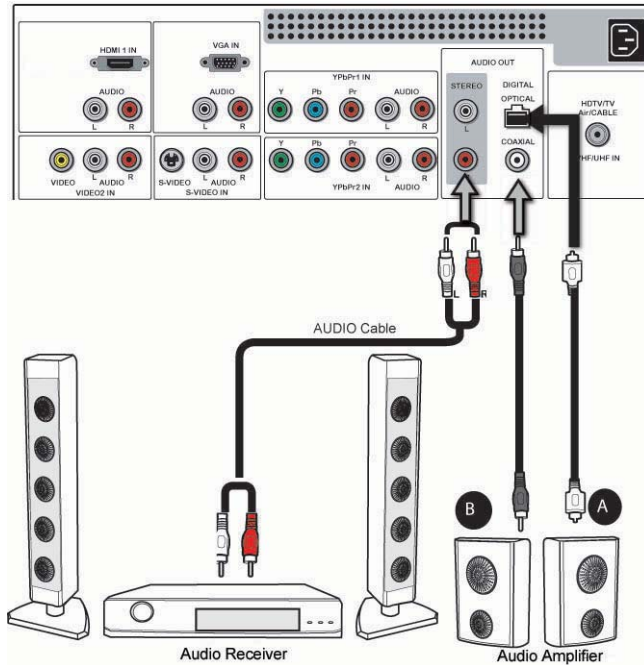

- 1 Use an audio cable to connect the audio receiver's audio LINE IN jacks to LCD TV's AUDIO OUT jacks.
- 2 Connect all AC power sources, before turning on the power switch of the LCD TV or other connected equipment.
- 3 Press the  button on the remote to turn on the LCD TV.

Chapter 3

USING THE FEATURES

Wide Screen Viewing

Wide Screen function allows viewing of 4:3/16:9 images in wide screen mode, cycling through the following wide screen settings. Press the P.SIZE button repeatedly to select the screen format you want.

1

FULL

Stretches the image vertically and horizontally to keep the image size consistent in the center of the screen and stretches the sides

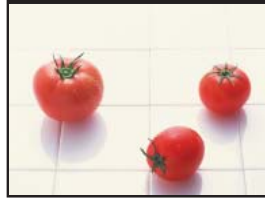

NORMAL is not available when you are watching 720p, 1080i, or 1080p source.

2

ZOOM

Stretches the image vertically and horizontally to fill the screen at 1:2.35 aspect ratio

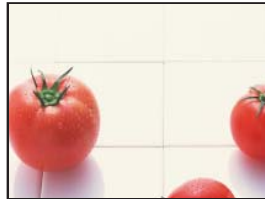

3

WIDE

Stretches the image vertically and horizontally to fill the screen at 1:1.85 aspect ratio





4

NORMAL

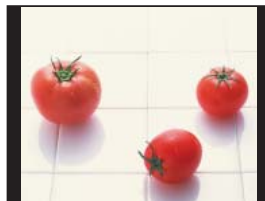
Displays at 4:3 aspect ratio



Operating the Menu

- 1 Press the  button to turn the LCD TV on.
- 2 Press the MENU button on the remote control, the on-screen menu will appear on the screen. Use the   buttons to select your main menu option.

VIDEO MENU:

Allows you to make adjustments to your picture settings.

- If the signal source is TV/VIDEO/S-VIDEO/YPbPr/HDMI, the VIDEO MENU appears as:
- If the signal source is VGA, the VIDEO MENU appears as:

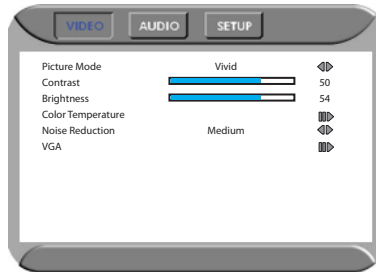
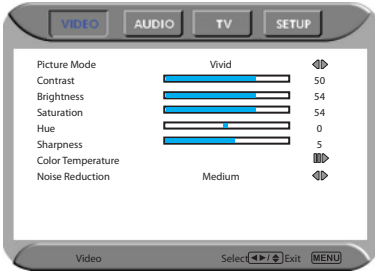

AUDIO MENU:

Allows you to customize the audio options and effects.

- If the signal source is VIDEO/S-VIDEO/YPbPr/HDMI/VGA, the AUDIO MENU appears as:
- If the signal source is TV, the AUDIO MENU appears as:

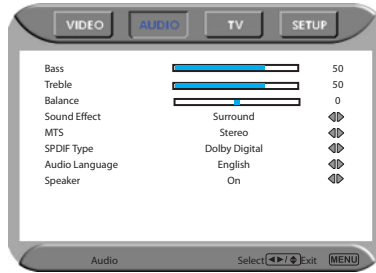
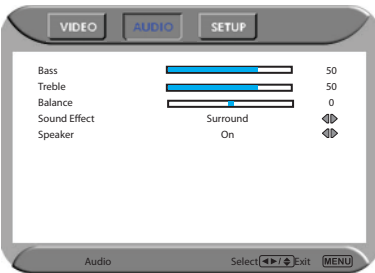

TV MENU:

Allows you to edit and label channels.

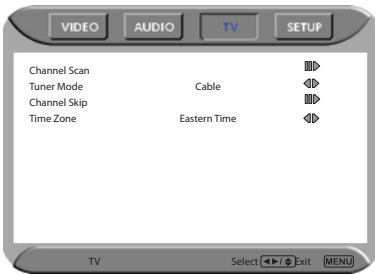

ENGLISH

SETUP MENU:

Allows you to set up a variety of features: Language, Closed Caption, factory reset, Parental Control sleep timer.

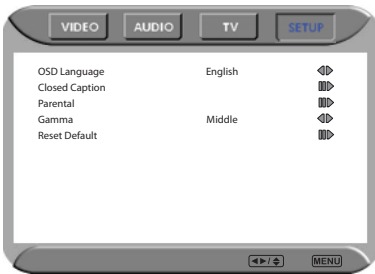

- 3 Use the ▲▼ buttons to highlight the option of the sub-menu, and press the OK button. While in adjustment mode, and use the ◀▶ buttons to change the value of the item.
- 4 Press the EXIT button to exit the menu.

Customizing the VIDEO Settings

- 1 Press the **⏻** button to turn the LCD TV on.
- 2 Press the MENU button on the remote control to display the Main menu, and use the **◀▶** buttons to select the VIDEO.
- 3 Use the **▲▼** buttons to highlight an individual VIDEO option, use the **◀▶** buttons to change the setting, and press the MENU to exit the menu

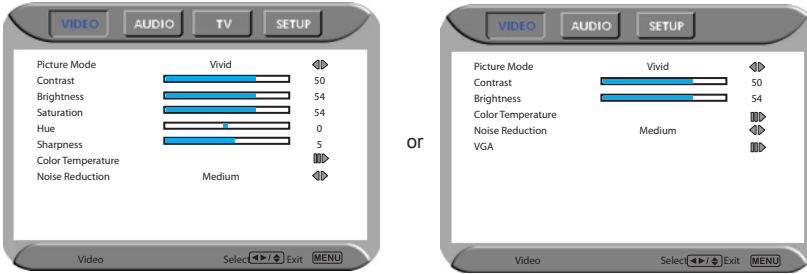

- 4 The VIDEO menu includes the following options:

Picture Mode	Cycles among display types: Vivid/Hi-Bright/Cinema/Sport/User
Contrast	Controls the difference between the brightest and darkest regions of the picture
Brightness	Controls the overall brightness of the picture
Saturation	Controls the color intensity
Hue	Controls the difference between the green and red regions of the picture
Sharpness	Increase this setting to see crisp edges in the picture; decrease it for soft edges

Color temperature

Adjusts color components independently to achieve a warm or cool effect: Cool/Nature/Warm/User

- Warm: Increases red tint
- Nature: Increases natural tint
- Cool: Increases blue tint
- User: Allows the user to adjust red, green and blue color component levels independently.

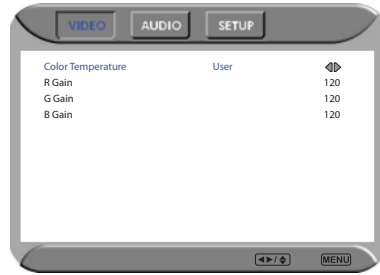

Noise Reduction

Select to reduce the noise level of connected equipment: Off/Low/Strong /Medium.

VGA

Press the **OK** button to enter the VGA Setting:

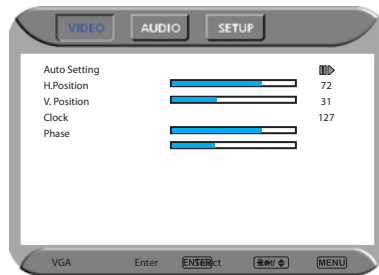

- Auto Setting Press the **OK** button to automatically adjust the display settings to optimize performance based on the VGA mode
- H. Position Adjusts the position of the picture left and right in the window
- V. Position Adjusts the position of the picture up and down in the window
- Clock Controls the width of the picture based on the VGA mode
- Phase Controls the signal phase, which can improve focus clarity and image stability based on the VGA mode

Customizing the AUDIO Settings

- 1 Press the **⏻** button to turn the LCD TV on.
- 2 Press the MENU button on the remote control to display the Main menu, and use the **◀▶** buttons to select the AUDIO.
- 3 Use the **▲▼** buttons to highlight an individual AUDIO option, use the **◀▶** buttons to change the setting, and press the MENU to exit the menu

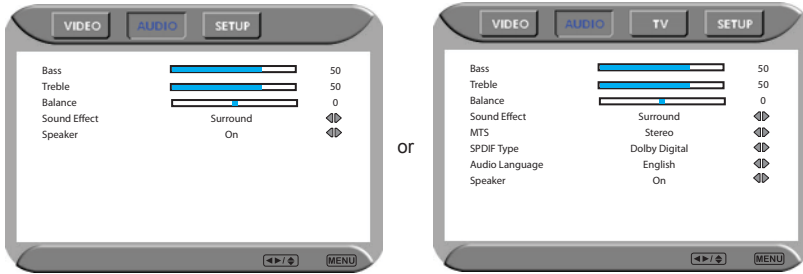







- 4 The AUDIO menu includes the following options:

Bass	Controls the relative intensity of lower-pitched sounds
.....	
Treble	Controls the relative intensity of higher pitched sounds
.....	
Balance	Adjusts the relative volume of the speakers in a multiple speaker system
.....	
Sound Effect	Allows selection of an audio-enhancement technique from among the following options: Surround/Live/Dance/Techno/Classic/Soft/Rock/POP/Off
.....	
MTS	Allows you to listen to high-fidelity stereo sound while watching TV
	<ul style="list-style-type: none"> ▪ Stereo: Use separate audio tracks for left and right speakers, if available ▪ SAP: You can enjoy a second audio program from the speakers while watching a scene in the original program ▪ Mono: Allows mono output (useful when stereo is noisy or inconsistent)
.....	

SPDIF Type	Allows to selection of the digital sound format: PCM/OFF/Dolby Digital <ul style="list-style-type: none">▪ PCM: The external audio system is connected to the AUDIO OUT (L/R) of the LCD TV▪ Dolby Digital: The external audio system is connected to the AUDIO OUT DIGITAL (OPTICAL or COAXIAL) of the LCD TV▪ OFF: Select OFF to turn off the external audio system
Audio Language	Allows to select the audio language:English/Spanish/French.
Speaker	Allows to select to turn on or off the TV speakers.

Customizing the TV Settings

- 1 Press the  button to turn the LCD TV on.
- 2 Press the MENU button on the remote control to display the Main menu, and use the   buttons to select the TV.
- 3 Use the   buttons to highlight an individual TV option, use the   buttons changes the setting, and press the MENU exits the menu.

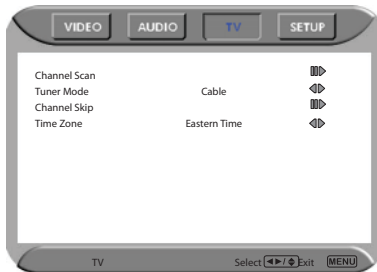

- 4 The TV menu includes the following options:

Channel Scan	Press the OK button, the Channel Scanning automatically creates a list of receivable channels.
Tuner Mode	Allows selection between CATV cable and antenna signal sources: <ul style="list-style-type: none"> ▪ AIR Choose this setting if you are receiving TV channels with an antenna (over the air) ▪ Cable Choose this setting if you are receiving TV channels with a CATV (cable TV)
Channel Skip	Allows addition/removal of channels on the channel list. <ol style="list-style-type: none"> 1 Press the OK button to display the Channel Skip menu:



- Press the **▼** button to select the desired channel, and press the **OK** button repeatedly to select show () or hide()

Favorite List

- Select Favorite List from the TV option and press the **OK** button. The Favorite List menu appears:

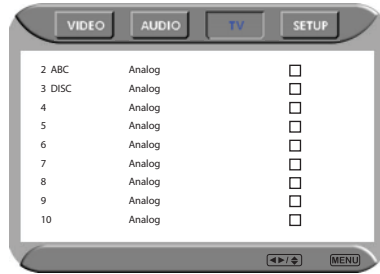

- Press the **▼** button to select the desired channel, and press the **OK** button repeatedly to select show () or hide()

Time Zone

Allows selection of regional TV systems of USA: Eastern Time/Indiana/Central time/Mountain Time/Arizona/Pacific Time/Alaska/Hawaii

Customizing the SETUP Settings

- 1 Press the **⏻** button to turn the LCD TV on.
- 2 Press the MENU button on the remote control to display the Main menu, and use the **◀▶** buttons to select the SETUP.
- 3 Use the **▲▼** buttons to highlight an individual SETUP option, use the **◀▶** buttons to change the setting, and press the MENU to exit the menu.



- 4 The SETUP menu includes the following options:

OSD Language Selects to display all on-screen menus in your language of choice: English/French/Spanish

Closed Caption Allows to select from analog or digital closed caption modes and press the **OK** button. The Closed Caption list appears:

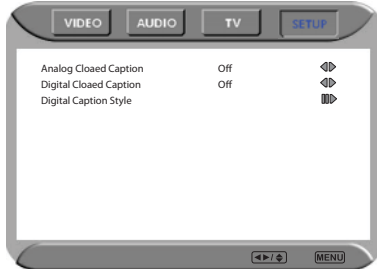

1 Analog Closed Caption:

Press the **◀▶** buttons to select the basic analog closed caption options: OFF/CC1/CC2/CC3/CC4

- CC1 /CC2 /CC3 /CC4:
Display a printed version of the dialog and sound effects of the program being viewed
- T1/T2:
Display station information presented using either half or the whole screen
- T3/T4:
Extended Data Services. For example: Network name, program name, program length, etc.

- ② **Digital Closed Caption:**
Press the ◀▶ buttons to select the digital closed caption options:
Service1/Service2/Service3/Service4/Service5/Service6/OFF

Note: The setting here will be applied to each DTV channel

- ③ **Caption Style:**
Press **OK** button to customize the settings for digital closed caption option:

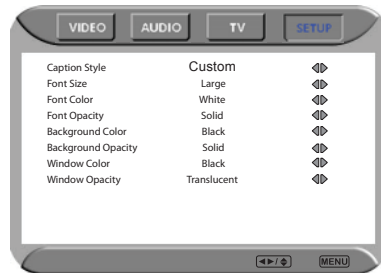

Parental

The Parental Control can be set up to the TV to block Channel, Video Source and to change password.

- ① Use the ▼ button to select the Parental, and press the OK to display the Parental menu
- ② Use the Program Block function, must enter a four-digit password. The factory password is 0000
- ③ The Parental list appears:
 - Program Block Allows to setup the TV and MPA Rating Lock options (refer to "Using the Program Block Setting").

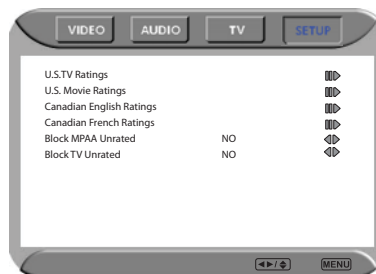

- Channel Block Allows to block digital channels.

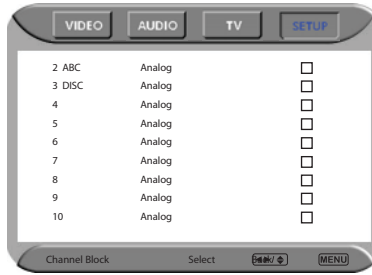

- Input Block Selects to block a Input source signal

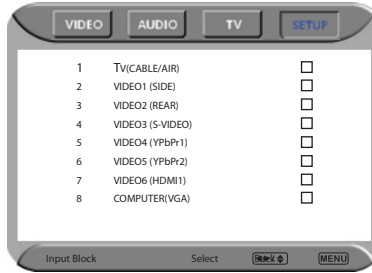

- Change Password Selects to change your password

Gamma Allows adjustment of the display's gamma correction, which fine tunes both brightness and red/green/blue ratios: Bright/Dark/Middle.

Reset Default Press the OK button to restore factory settings

Using the Program Block Settings

ENGLISH

- 1 Press the MENU button on the remote control to display the Main menu, and use the ◀▶ buttons to select the SETUP.
- 2 Use the ▼ buttons to highlight **Parental**, and press the OK button.



- 3 Use the Parental function, must enter a four-digit password. The factory password is 0000.

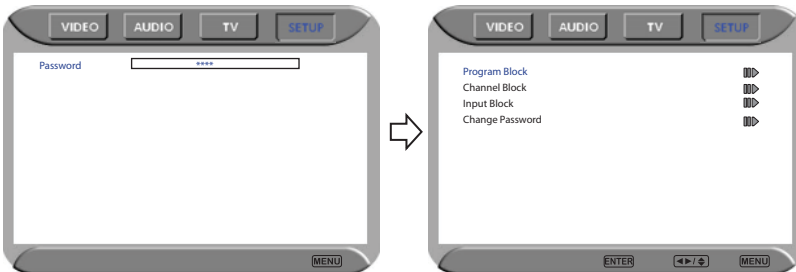

- 4 Use the ▼ button to select the Program Block, and press the OK to display the Program Block menu.

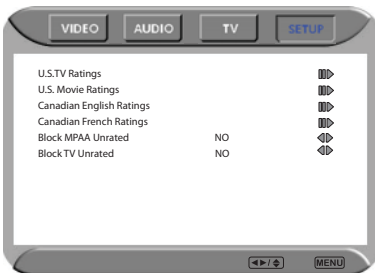

5

The Parental block menu includes the following options:

U.S. TV Ratings	Selects to activate the TV Rating programs.
U.S. Movie Ratings	Selects to activate the MPAA Rating programs
Canadian English Ratings	Selects to activate the English Rating programs of Canada.
Canadian French Ratings	Selects to activate the French Rating programs of Canada
Block MPAA Unrated	<ul style="list-style-type: none">▪ YES: Block all movies that are broadcast without a MPAA rating.▪ NO: Allows all movies that are broadcast without a MPAA rating
Block TV None Rating	<ul style="list-style-type: none">▪ YES: Block all movies that are broadcast without a TV rating.▪ NO: Allows all movies that are broadcast without a TV rating.

U.S. TV Ratings

The U.S.TV Rating has 2 rating methods: Content-Based Rating and Age-Based Rating. The U.S.TV Rating includes the following options:

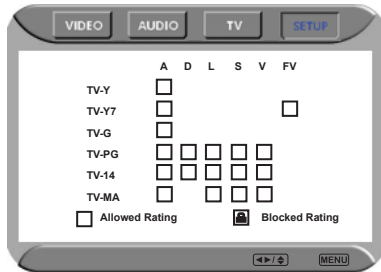

AGE-BASED



RATING	DESCRIPTION
TV-Y	All children
TV-Y7	Directed to children age 7 and older
TV-G	General Audience
TV-PG	Parental Guidance suggested
TV-14	Parents strongly cautioned
TV-MA	Mature Audience only

CONTENT-BASED

RATING	DESCRIPTION
FV	Fantasy violence
D	Suggestive dialogue
L	Strong language
S	Sexual situations
V	Violence
ALL	All contents are blocked

		CONTENT-BASED				
		FV	D	L	S	V
AGE-BASED	TV-Y					
	TV-Y7	✓				
	TV-G					
	TV-PG		✓	✓	✓	✓
	TV-14		✓	✓	✓	✓
	TV-MA			✓	✓	✓

✓ : To block programs by both content and age.



Use the ◀▶▲▼ buttons to select the rating you want and press the OK button repeatedly to select BLOCK  UNBLOCK .

Canadian English Ratings

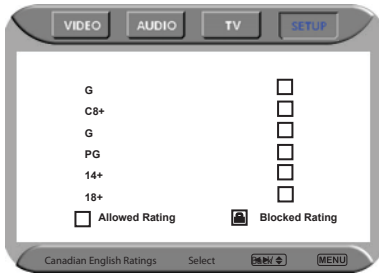
The Canadian English Ratings includes the following options:



RATING	DESCRIPTION
G	All children
C8+	Children 8 years and older
G	General programming
PG	Parental guidance
14+	Viewers 14 and older
18+	Adult programming



Use the ◀▶▲▼ buttons to select the rating you want and press the OK button repeatedly to select BLOCK  UNBLOCK .

Canadian French Ratings

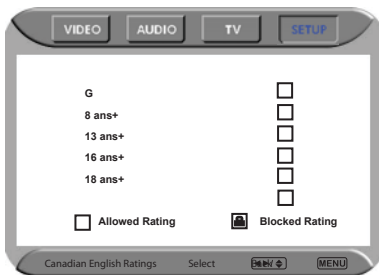
The Canadian French Ratings includes the following options:



RATING	DESCRIPTION
G	General programming
8 ans+	Not recommended for ages under 8
13 ans+	Not recommended for ages under 13
16 ans+	Not recommended for ages under 16
18 ans+	Programming restricted to adults.



Use the ◀▶▲▼ buttons to select the rating you want and press the OK button repeatedly to select BLOCK  UNBLOCK .

U.S. Movie Ratings

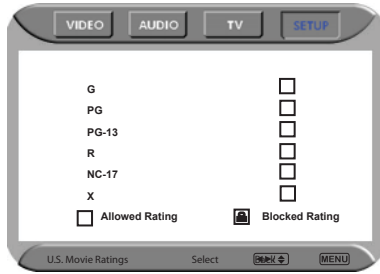
The U.S. Movie Ratings is used for original movies rated by the Motion Picture Association of America(MPAA) as broadcasted on cable TV and not edited for television. The U.S. Movie Ratings includes the following options:



RATING	DESCRIPTION
G	General Audiences. Movie is appropriate for all ages
PG	Parental Guidance Suggested. May contain material not suited for younger viewers
PG-13	Contains content that may not be appropriate for viewers under the age of 13
R	Restricted. Contains adult content, no one under 17 admitted without parent
NC-17	No one 17 and under admitted
X	No one 17 and under admitted

Use the ◀▶▲▼ buttons to select the rating you want and press the OK button repeatedly to select BLOCK  UNBLOCK 

ENGLISH

Using the Program Guide

The Program Guide feature brings all sorts of information to your screen, such as program title, program duration, time remaining, rating information, closed caption, availability, etc.

- 1 With the LCD TV connected to a television programming source, press the INPUT button on the remote control and use the ▲▼ buttons to select TV and press the OK button.
- 2 Press the GUIDE button on the remote control, the Program Guide will appear on the screen:

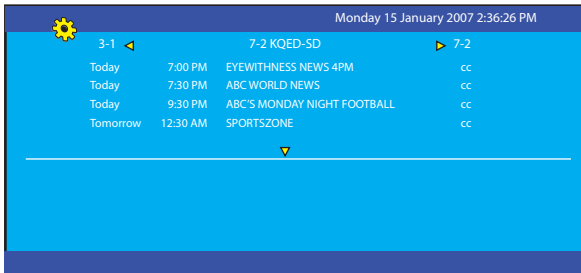

- 3 Press the ◀▶ button to select the channel.
- 4 Press the ▲▼ button to select the program from a list, the Program Guide provides introduction about the current program being shown on each channel. The Program information in the guide is provided by the broadcasters. It may sometimes include only the channel number, without a program title or description.

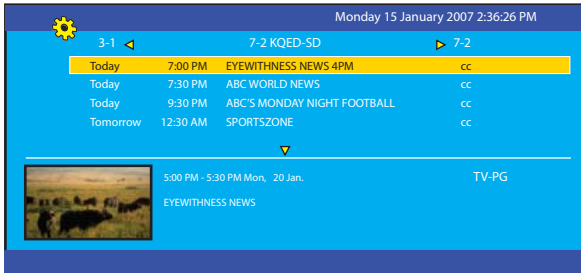

- 5 Press the GUIDE button again on the remote control to exit the Program Guide

SPECIFICATIONS

ENGLISH

MODEL		FLX-2610	FLX-3210
LCD Panel	Panel Size	26" TFT LCD	32" TFT LCD
	Brightness	500 cm2	400 cm2
	Contrast Ratio	800:1	1200:1
Max. Resolution		1366x768	1366x768
Input Connector	VIDEO/AUDIO(L/R)	2	2
	S-VIDEO/AUDIO(L/R)	1	1
	YPbPr/AUDIO(L/R)	2	2
	VGA/AUDIO(L/R)	1	1
	HDMI/AUDIO(L/R)	1	1
	AUDIO OUT(L/R)	1	1
	OPTICAL/COAXIAL	1	1
	HEADPHONE	1	1
	Power Source		AC100~240V, 50/60HZ, 2.2A
Power Consumption		180 W, standby < 5 W	180 W, standby < 5 W
Dimension		26.7 w x 22.1 h x 7.9 d inch	31.7 w x 25.0 h x 8.4 d inch
WEIGHT		31.97 LB	39.5 LB

MODEL		FLX-3710
LCD Panel	Panel Size	37" TFT LCD
	Brightness	500 cm2
	Contrast Ratio	800:1
Max. Resolution		1366x768
Input Connector	VIDEO/AUDIO(L/R)	2
	S-VIDEO/AUDIO(L/R)	1
	YPbPr/AUDIO(L/R)	2
	VGA/AUDIO(L/R)	1
	HDMI/AUDIO(L/R)	1
	AUDIO OUT(L/R)	1
	OPTICAL/COAXIAL	1
	HEADPHONE	1
	Power Source	
Power Consumption		275 W, standby < 8 W
Dimension		36.6 w x 28.2 h x 9.4 d inch
WEIGHT		54 LB

20070228